

freud.

**Spoilboard
surfacing cutters**

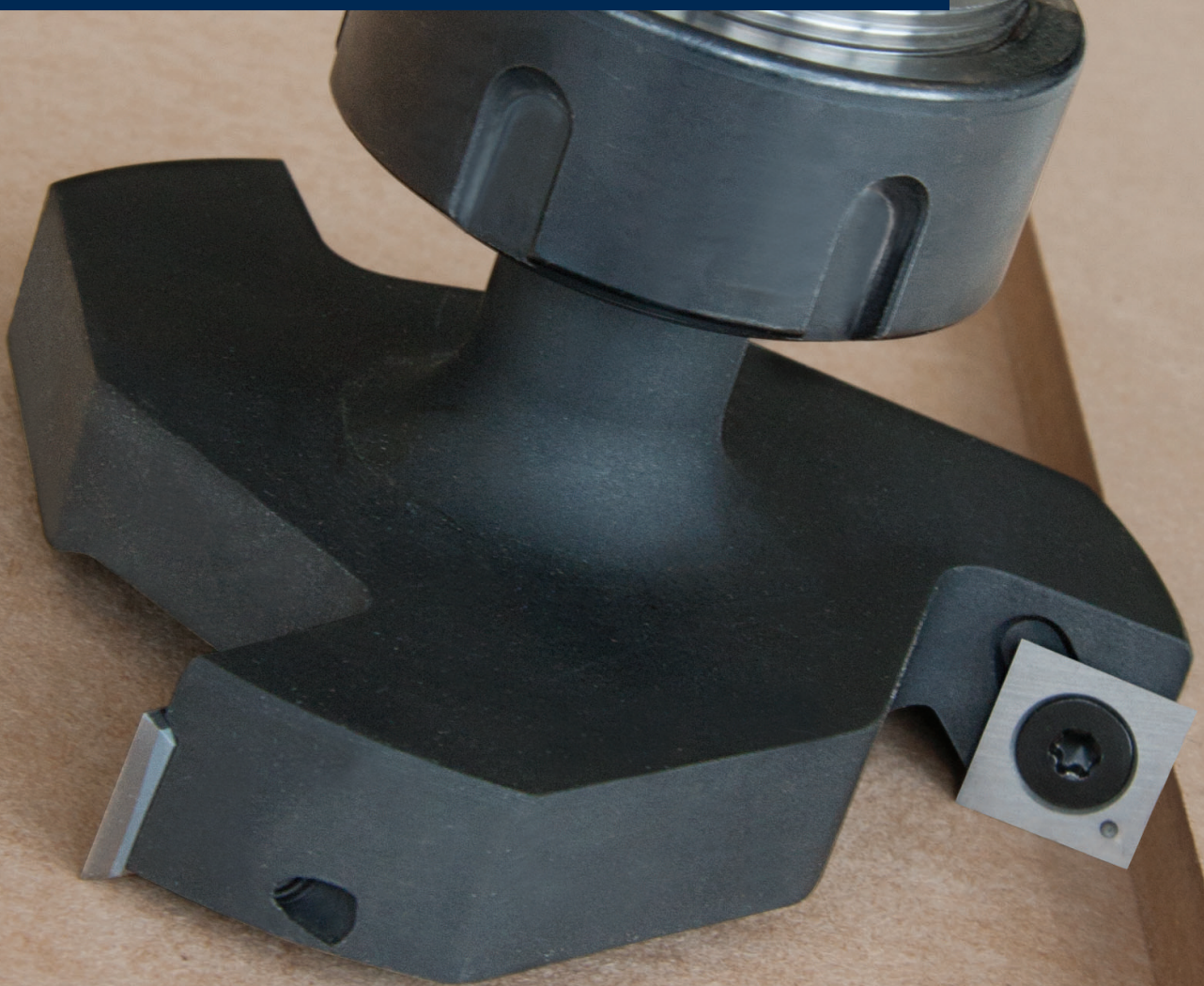

Spoilboard surfacing cutters

Product benefits

- **Flawless finishing thanks to the shear angle:**
The new range delivers a **perfect finishing**, as a result of the shear angle positioning of the knives.
- **Superior cutting performance:**
The NC12 cutters ensure the highest cutting performance and **vibration-free cuts**, thanks to tight body mechanical tolerances, tool dynamic balancing and extremely precise knives.
- **Dedicated TiCo Carbide formula:**
In-house manufactured hi-density Titanium Cobalt Carbide that delivers perfect finishing and extremely **longer cutting life**.

Applications

Surfacing/skimming and rabbeting.

Materials

Wood and derivate panels.

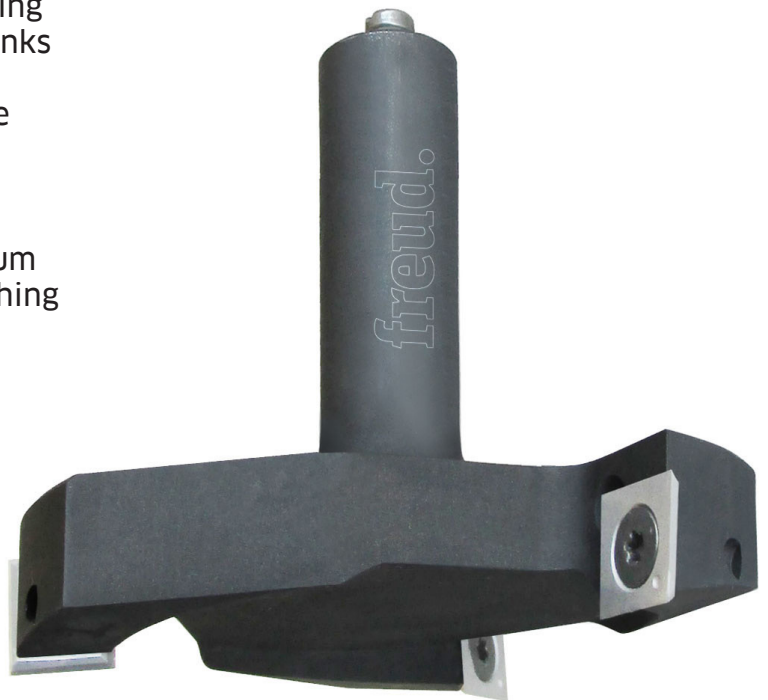

Knife wear

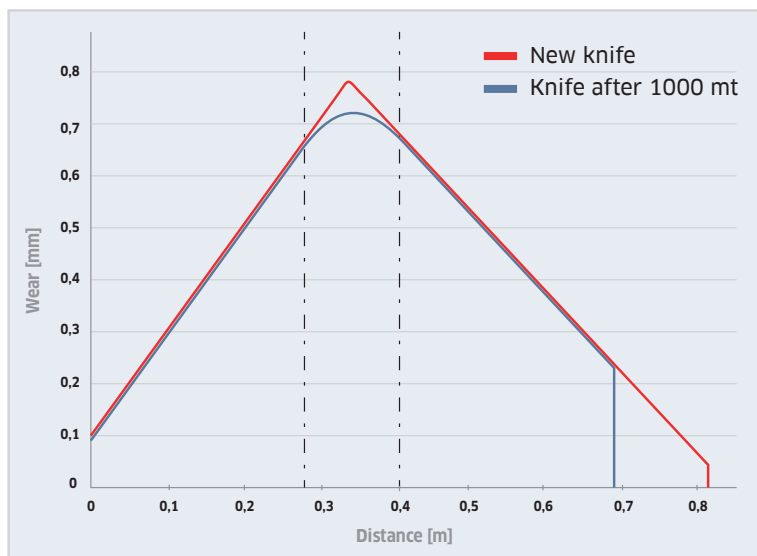

Wear has been measured as the distance between new and worn edge.

Higher resistance to wear

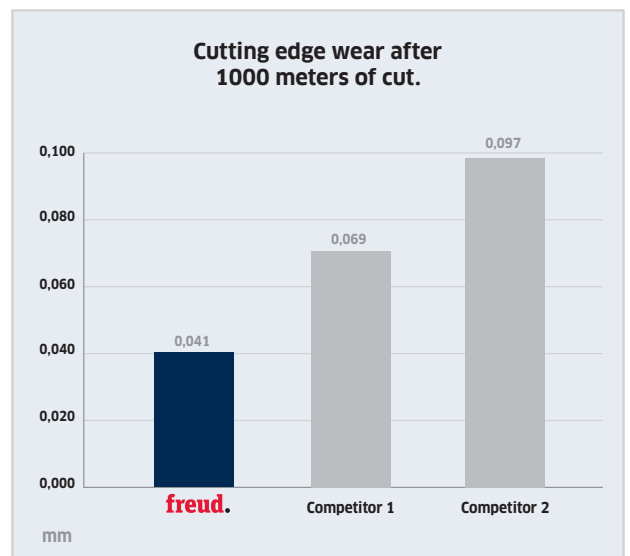

Test results prove that freud NC12 deliver at least 40% higher resistance to wear.

NC12M

Spoilboard surfacing cutters

Positive shear angle:
solid wood and other board materials





D	h	H	A	Z	Code	SAP
mm	mm	mm	mm			
60	13	80	12	2	NC12M60	F03FR03949
80	13	80	20	3	NC12M80	F03FR03884
100	13	80	20	3	NC12M100	F03FR03886

D	h	H	A	Z	Code	SAP
inch	inch	inch	inch			
2-1/2"	1/2"	3"	1/2"	2	NC12M61	F03FR03951
4"	1/2"	3"	3/4"	3	NC12M101	F03FR03888

Negative shear angle:
LDF, MDF or composite particle spoilboard for nesting

D	h	H	A	Z	Code	SAP
mm	mm	mm	mm			
60	13	80	12	2	NC12M60N	F03FR03950
80	13	80	20	3	NC12M80N	F03FR03885
100	13	80	20	3	NC12M100N	F03FR03887

D	h	H	A	Z	Code	SAP
inch	inch	inch	inch			
2-1/2"	1/2"	3"	1/2"	2	NC12M61N	F03FR03952
4"	1/2"	3"	3/4"	3	NC12M101N	F03FR03889

Spare parts		Dimensions	Code	SAP
		mm		
	Spur	14 x 14 x 2	RG01MAI310	F03FH03791
	Screw	M5 x 8	VT05M AA9	F03FA04444
	Hex nut	M4	2606M CE9	F03FA07360
	Slotted cheese head screw	M4 x 10	2611M DB9	F03FA07386
	Torx key	T20	CB03M CC9	F03FA00167

Optional square disposable spurs

L	H	S	Type	Quality of HW	α	Code	SAP
mm	mm	mm					
14	14	2	1	H00XA	31°	RG01MAH310	F03FH03037

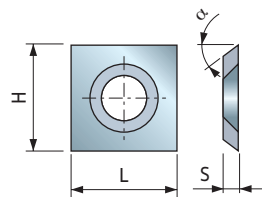
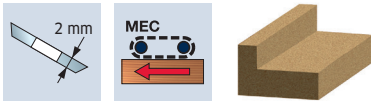
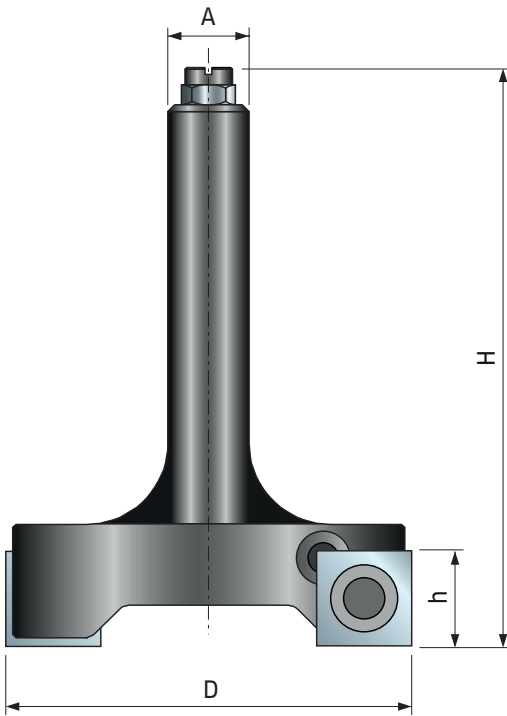

freud.

freud S.p.A.

Società Unipersonale

Via Remigio Solari, 7

33050 Pavia di Udine (UD) IT

Tel. +39 0432 551411

Fax +39 0432 551440

info@freud.it

www.freud.it